

EW9241V6N : brand new mixing tank - type VC-SCA from 200 L in SS AISI 316 (V4A)

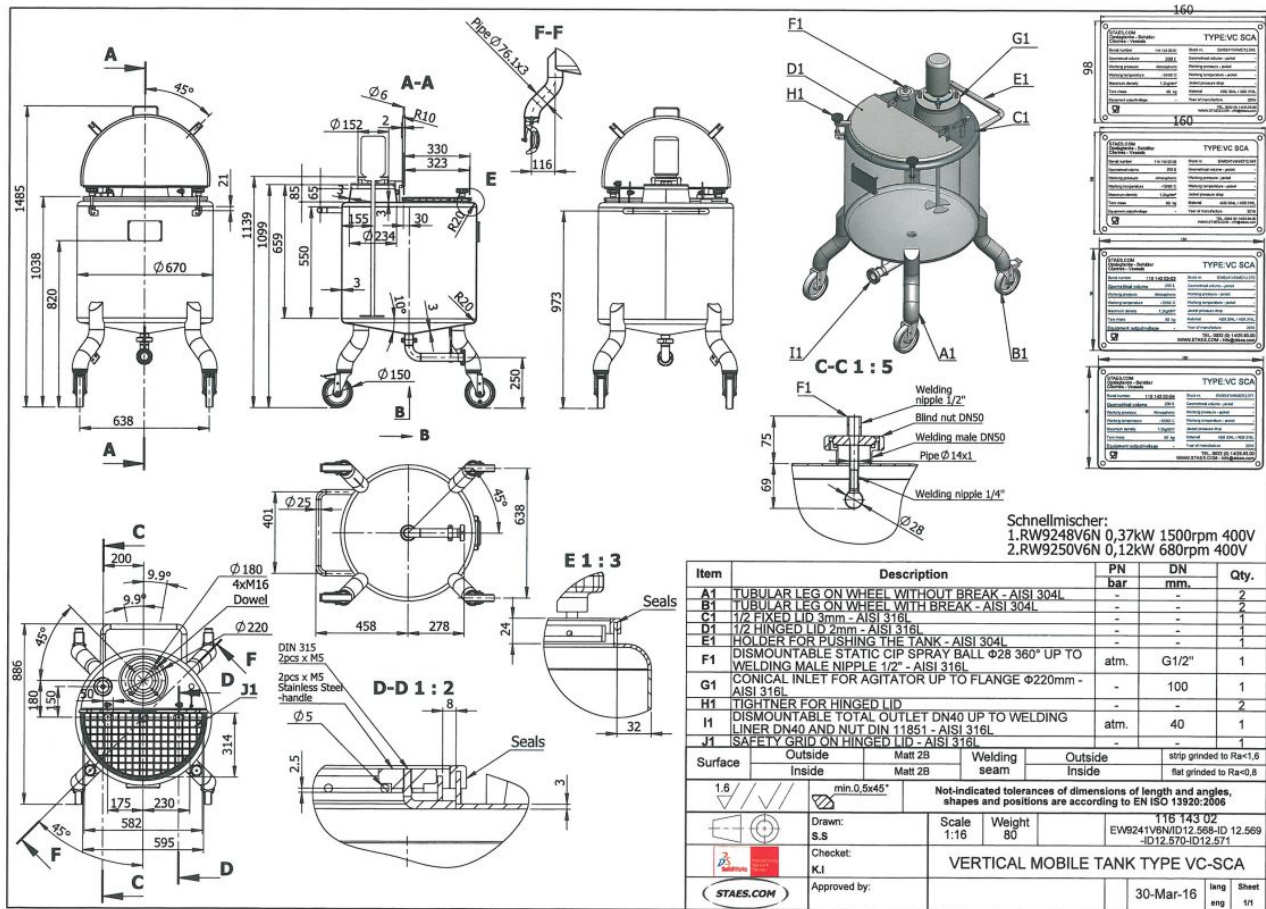

Technical drawing

Description of the article

ORDER NUMBER	EW9241V6N
Article type	brand new mixing tank - type VC-SCA
Additional information	delivered with food certificate; <i>article price without agitator</i> ; choice of 2 different types of agitators; see options; (The article can also be purchased without options); Ra=$\leq 0.8\mu$
Volumetric volume (L)	200 L
Max. density P (kg/m ³)	1.200 kg/m ³
Ra inner weld	0,80 μ
Finish stainless steel	2b
Max. temperature (°C)	on request
Please give us the temperature of your product so we can check the seals.	
Min. temperature (°C)	-10 °C
Wet parts of tank	SS AISI 316 (V4A)
Model	vertical
Configuration	single-skin
Heat exchanger	no
Insulation	no
Mobile tank	yes

Top type	half hinging lid °
Shape of tank	cylindrical
Bottom type	conical 10 °
Total discharge	yes
Fixation points	4 casters

Overview materials

Material wet parts	SS AISI 316 (V4A)
Gasket manway(s)	EPDM
Valve	RVS 316L
Fixation point(s)	RVS 304

Equipment

Suitable for food industry	yes
Documents included	yes, optional
Technical drawing included	yes
Registration plate on the tank	yes
Flange for agitator	yes
CIP spray ball	no, optional
Tank outlet	inside Ø 40 mm
Total outlet valve	no, optional

Agitators

Agitator	no, optional
Agitator type	propeller agitator
Position engine	at the top
Number of revolutions	1.500 rpm
Power	0,37 kW
Voltage	400 V - three-phase
Agitator type 2	propeller agitator
Position engine	at the top
Number of revolutions	680 rpm
Power	0,12 kW
Voltage	400 V - three-phase

Wall thicknesses of the inner tank

Top	3 mm
Cylinder	3 mm
Bottom	3 mm

Dimensions of the tank

Internal diameter tank	670 mm
Distance from outlet to ground	250 mm
Outer diameter tank	676 mm
Cylinder height	550 mm
Total height of tank	1.620 mm
Empty weight tank	70 Kg

Price, availability and conditions:

Unit price for item	€ 6.750 + VAT per piece
Wood for the transport	€ 140 + VAT per piece
Total	€ 6.890 + VAT per piece
Number available	4 Quantity in stock at Olen: 4 In external storage: 0 In production:
Supplementary price for the options	
Bekijk mogelijke opties op onze website	
Delivery	Ex Olen - Belgium
Payment	40% Upon order, balance upon pick-up

GENERAL TERMS AND CONDITIONS OF SALE

Art. 1. DEFINITIONS

- **Seller:** STAES.COM bvba, 2250 OLEN (Belgium), Hoogbuul 44A, CBE: 0450.544.412;
- **Buyer:** Any party agreeing to buy goods from the seller.
- **In writing:** All communications, notifications or formal notices are deemed to have been made in writing if they are sent by email, by fax, by registered mail or by ordinary mail.
- **Fixed compensation for damages:** Any fixed compensation for damages referred to in these terms and conditions serves as an allowance for expenses and efforts made, damage suffered, loss of opportunity and loss of profits due to any contractual default by the buyer or due to the execution of a (unilateral) right by the seller. The fixed compensation for damages relieves the seller of his duty to give proof of the real damage suffered, without prejudice to his right to prove any higher damage. By buying the goods, the buyer confirms that the fixed compensation for damages corresponds to the foreseeable real damage suffered by the seller.

Art. 2. ORDER CONFIRMATION

- The seller shall only be bound by order confirmations that are sent by him. The agreement comes into force upon receipt by the buyer of the seller's order confirmation. This agreement is fully and solely governed by the general terms and conditions of sale stated in the order confirmation, in the invoices and on the website of the seller, to the exclusion of the buyer's own terms and conditions, even if the latter are communicated afterwards.
- All cancellations are to be made in writing. They shall only be valid subject to acceptance in writing by the seller. In case of cancellation the customer shall owe a fixed compensation for damages equal to 30% of the sales price agreed upon. This compensation for damages will be settled automatically with any advances already paid or with any other debts the buyer owes to the seller.

Art. 3. DESCRIPTION OF THE GOODS TO BE SUPPLIED

- The subject of the sales agreement is described in the order confirmation and/or at the front page of the invoice. The seller's obligation to supply is limited to this subject.

Art. 4. PRICE

- The price shall be the price as specified in the offer, unless if the seller finds himself compelled to adjust the price in line with the developments of his fixed and/or variable costs as a result of changes to the structure thereof (raw materials, wages, energy, ...). Any price reviews shall occur in compliance with the statutorily permissible standards. In said case, the new price as detailed on the front page of the invoice shall apply.
- All prices are exclusive of VAT.
- All prices are excluding delivery, transport and assembly/fitting, unless if specified otherwise on the front page of the invoice.

Art. 5. DELIVERY

- Delivery times are communicated for informational purposes only and as such are not binding, unless if agreed upon explicitly between the parties. Delays in the delivery time can never give rise to penalties, compensations for damages or the dissolution of the agreement.
- After the sales agreement has come into force as described in art. 2, the buyer is bound to accept the goods he has bought. The buyer must accept the goods within 30 days as from the written notification by the seller, stating that the goods are ready for delivery or collection. In case the buyer does not observe his duty to accept and remains in default seven days after the seller has sent a written formal notice in this respect, the seller is entitled to dissolve the sales agreement extra-judicially and with immediate effect at the buyer's expense. In this case the buyer owes to the seller a fixed compensation for damages equal to 30% of the sales price agreed upon. This compensation will be settled automatically with the advance already paid by the buyer. In case a fixed delivery period has been agreed, it will be stated on the order confirmation and/or on the invoice. The delivery period only starts on the date on which the following requirements are duly met:
 - the buyer is in possession of the order confirmation sent by the seller;
 - the seller has received the advance agreed upon;
 - if necessary, the technical drawing has been signed for approval by the buyer.

Art. 6. INSPECTION

- All goods can be inspected freely at the seller's premises following appointment by phone. Any non-destructive inspections are allowed, provided they are performed by a certified inspection body. Any expenses relating to such inspections shall be incurred by the buyer.
- The goods can only be sold in the state they are in ("as is"), as known to and inspected by the customer, unless if clearly agreed otherwise in the sales agreement and/or the invoice.

Art. 7. TRANSFER OF OWNERSHIP

- The goods delivered shall remain the property of the seller until payment in full has been received of the principal, including any costs and interests.
- All deliveries of goods take place at the expense and at the risk of the buyer, who should take out an insurance cover to protect himself against any damage.
- If the transport is to be organised by the seller, he will always be considered as being appointed by the buyer.

Art. 8. PAYMENT

- Unless specified otherwise on the invoice, the payments are to be made as follows:
 - prior to collection or delivery of the goods;or
 - 40 or 50% advance upon order, according to the specific agreements made;
 - the balance prior to collection or delivery.
- The collection or delivery of the goods can only take place after payment as stipulated in art. 8.1. If the seller is to transport the goods to the buyer, the former is entitled to take back the goods in case the buyer can not provide any proof of payment of the corresponding sales price. The expenses for such pointless transport are borne by the buyer and no new delivery of the goods can take place until the buyer has paid these expenses.
- If the advance due is not credited to the seller's account no later than seven days after the buyer has been requested to do so in writing, the seller is entitled, at his own discretion, to suspend the execution of the agreement or to dissolve the agreement ipso jure at the expense of the buyer, without formal notice and with immediate effect by means of a written notification to this effect. In case of dissolution of the agreement a fixed compensation for damages equal to 30% of the total sales price is due to the seller. This compensation for damages is settled automatically with any debts the buyer has against the seller.
- The invoice amount is to be paid net. Discounts and banking costs shall be at the buyer's expense. Discounts for immediate payment shall be allowed only if they have been explicitly agreed upon beforehand. Such discounts are then calculated in the price reduction agreed upon for the sale.
- In the event of non-payment or late payment of an invoice, the invoice amount shall be increased by a fixed compensation for damages equal to 10% and interests equal to 10% per year shall be due as from the maturity date. The above-mentioned compensation for damages and interests are due ipso jure and without any prior notice. Upon repeated default of payment the seller is entitled to dissolve the sales agreement extra-judicially. In this case the buyer is due a fixed compensation for damages to the seller, equal to 30% of the sales price agreed upon. This compensation for damages will be settled automatically with the advance paid by the buyer.
- Upon non-payment of a single invoice on the maturity date, the balance of all other invoices of the seller, even those that are not yet due, shall become claimable ipso jure with immediate effect.
- Drawing and/or accepting bills of exchange or any other tradable documents shall not entail any renewal of debts or any derogation of the terms and conditions of sale.
- Without prejudice to what has been specified in art. 13.1, invoices must be protested no later than 7 days following the invoice date in case of disputes. The customer shall mention the invoice date and the invoice number.

Art. 9. GUARANTEES

- In the event the seller's confidence in the solvency of the buyer is undermined as a result of acts of judicial foreclosure against the buyer and/or any other demonstrable events casting doubt on the due execution of the commitments taken on by the buyer and/or making it impossible to remain confident of such due execution, the seller

reserves the right to claim appropriate guarantees of the buyer. Should the buyer refuse to give such guarantees, the seller is entitled to cancel the entire order or part thereof unilaterally, even if the goods have already been delivered to the buyer, either as a whole or in part. In such case the buyer owes a compensation for damages equal to 30% of the sales price of the cancelled order to the seller. This compensation for damages can be settled automatically with the advance that has already been paid or with any other debts the buyer has against the seller.

- In case of bankruptcy (or any other form of concurrence or insolvency procedure) of the buyer, all claimable, liquid and transferable claims between the buyer and the seller will be settled automatically, in as far as such settlement is not prohibited by law.

Art. 10. RIGHT OF LIEN & OBJECTION OF NON-EXECUTION

- The buyer and the seller explicitly agree that all goods of the buyer that are located in the warehouses or the workshops of the seller, can be withheld by the seller by means of guarantee for the payment by the buyer of any amounts due for goods already delivered or for works already performed. New goods entrusted by the buyer for processing shall be deemed to replace the processed goods that were already returned. All goods the buyer entrusts to the seller for processing are deemed to be part of one and the same indivisible agreement, even if this agreement is performed in successive parts, comes into force by means of various successive order confirmations and/or if successive invoices are issued for such agreement.
- Any non-execution of commitments by the buyer gives the seller the right to suspend all of his commitments, without any prior notification or formal notice, until full remediation of the non-execution by the buyer. All commitments between the parties are deemed to be part of one and the same indivisible agreement, even if this agreement is performed in successive parts, comes into force by means of various successive order confirmations and/or if successive invoices are issued for such agreement.

Art. 11. FORCE MAJEURE

- Should the following events occur after the agreement has been concluded and prevent the execution of the agreement, they shall be considered to be instances of force majeure: strike, lock-out and any other situations that occur beyond the will of the seller, such as fire, mobilisation, requisitioning, embargo, monetary restrictions, riots, lack of transport means, lack of material, restrictions on the use of driving power, late deliveries by the suppliers of the seller.
- Should such circumstances occur, the time awarded to the seller to comply with his commitments shall be extended and the seller shall not be liable for the delays that have arisen as a result of the above-mentioned events.
- Should said circumstances last for longer than six months, either party shall be entitled to cancel the agreement by means of a registered letter; without any rights to any compensation for damages.

Art. 12. DISCLAIMER

- In all cases, even in case of serious misconduct, the seller's liability relating to defects in the goods delivered or the works performed by him, shall be limited to a compensation for damages equal to the principal amount of the invoice relating to such goods or works.

Art. 13. COMPLAINTS & DISPUTES

- Complaints are to be made in writing no later than fourteen days after delivery. Complaints made at a later date are inadmissible.
- Complaints relating to hidden defects must be made in writing to the seller immediately upon discovery and no later than 6 months after delivery. Complaints made at a later date are inadmissible.
- In case of disputes only the courts of Turnhout (Belgium) shall have jurisdiction, with the proviso that for disputes falling under the material jurisdiction of the Justice of the Peace, only the Justice of the Peace Court of Herentals (Belgium) shall have jurisdiction.
- The relationship between the buyer and the seller is governed solely by Belgian law, excluding the law resulting from the Vienna Convention of April 11, 1980 on international sales agreements relating to moveable property.
- All costs pertaining to the recovery of outstanding debts through the courts, including solicitor's fees, shall be recovered from the buyer.